

International
IOR Rectifier

30WQ04FN

SCHOTTKY RECTIFIER

3.5 Amp

$$I_{F(AV)} = 3.5\text{Amp}$$

$$V_R = 40\text{V}$$

Major Ratings and Characteristics

Characteristics	Values	Units
$I_{F(AV)}$ Rectangular waveform	3.5	A
V_{RRM}	40	V
I_{FSM} @tp = 5 μ s sine	500	A
V_F @3 Apk, $T_J = 125^\circ\text{C}$	0.49	V
T_J	-40 to 150	$^\circ\text{C}$

Description/ Features

The 30WQ04FN surface mount Schottky rectifier has been designed for applications requiring low forward drop and small foot prints on PC board. Typical applications are in disk drives, switching power supplies, converters, free-wheeling diodes, battery charging, and reverse battery protection.

- Popular D-PAK outline
- Small foot print, surface mountable
- Low forward voltage drop
- High frequency operation
- Guard ring for enhanced ruggedness and long term reliability

Case Styles



D-PAK (TO-252AA)

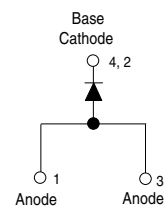

Voltage Ratings

Part number	30WQ04FN
V_R Max. DC Reverse Voltage (V)	40
V_{RWM} Max. Working Peak Reverse Voltage (V)	

Absolute Maximum Ratings

Parameters	30WQ...	Units	Conditions
$I_{F(AV)}$ Max. Average Forward Current * See Fig. 5	3.5	A	50% duty cycle @ $T_C = 135^\circ\text{C}$, rectangular wave form
I_{FSM} Max. Peak One Cycle Non-Repetitive Surge Current * See Fig. 7	500	A	Following any rated load condition and with rated V_{RRM} applied
	80		
E_{AS} Non-Repetitive Avalanche Energy	8.0	mJ	$T_J = 25^\circ\text{C}$, $I_{AS} = 1\text{ Amp}$, $L = 16\text{ mH}$
I_{AR} Repetitive Avalanche Current	1.0	A	Current decaying linearly to zero in 1 μsec Frequency limited by T_J max. $V_A = 1.5 \times V_R$ typical

Electrical Specifications

Parameters	30WQ...	Units	Conditions
V_{FM} Max. Forward Voltage Drop * See Fig. 1 (1)	0.53	V	@ 3A $T_J = 25^\circ\text{C}$
	0.67	V	@ 6A
	0.49	V	@ 3A $T_J = 125^\circ\text{C}$
	0.62	V	@ 6A
I_{RM} Max. Reverse Leakage Current * See Fig. 2 (1)	2	mA	$T_J = 25^\circ\text{C}$ $V_R = \text{rated } V_R$
	24	mA	$T_J = 125^\circ\text{C}$
$V_{F(TO)}$ Threshold Voltage	0.34	V	$T_J = T_J \text{ max.}$
r_t Forward Slope Resistance	37.33	$\text{m}\Omega$	
C_T Typical Junction Capacitance	189	pF	$V_R = 5V_{DC}$ (test signal range 100Khz to 1Mhz) 25°C
L_S Typical Series Inductance	5.0	nH	Measured lead to lead 5mm from package body
dv/dt Max. Voltage Rate of Change	10000	V/ μs	(Rated V_R)

(1) Pulse Width < 300 μs , Duty Cycle < 2%

Thermal-Mechanical Specifications

Parameters	30WQ...	Units	Conditions
T_J Max. Junction Temperature Range (*)	-40 to 150	$^\circ\text{C}$	
T_{stg} Max. Storage Temperature Range	-40 to 150	$^\circ\text{C}$	
R_{thJC} Max. Thermal Resistance Junction to Case	4.7	$^\circ\text{C}/\text{W}$	DC operation * See Fig. 4
wt Approximate Weight	0.3 (0.01)	g (oz.)	
Case Style	D - PAK		Similar to TO-252AA
Marking Device	30WQ04FN		

(*) $\frac{dP_{tot}}{dT_J} < \frac{1}{R_{th(j-a)}}$ thermal runaway condition for a diode on its own heatsink

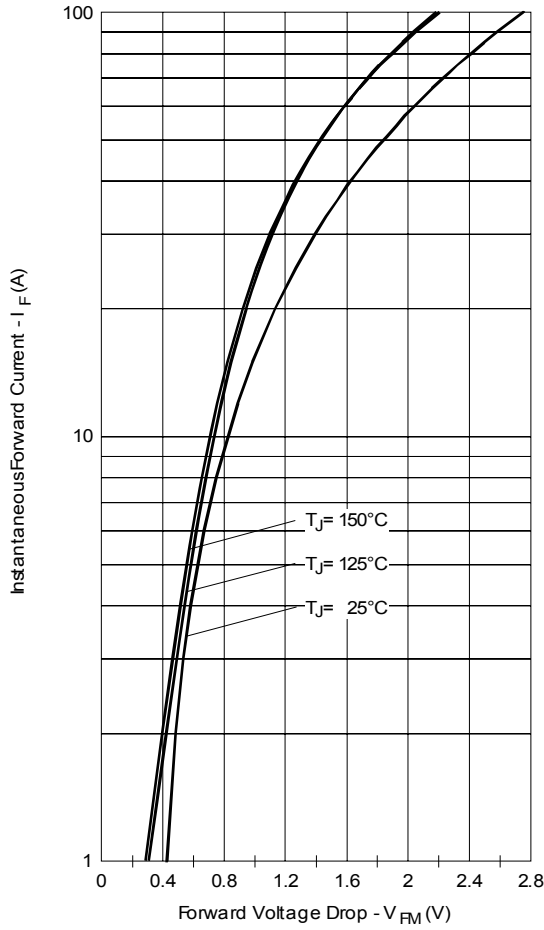

Fig. 1 - Maximum Forward Voltage Drop Characteristics

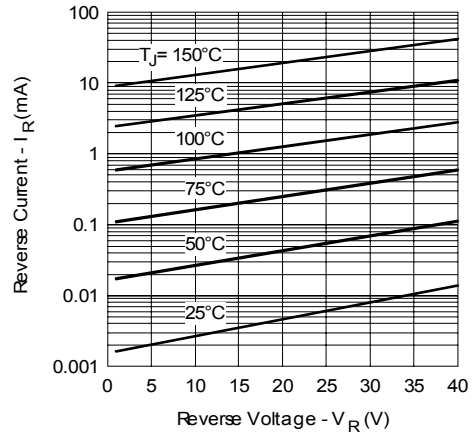

Fig. 2 - Typical Values of Reverse Current Vs. Reverse Voltage

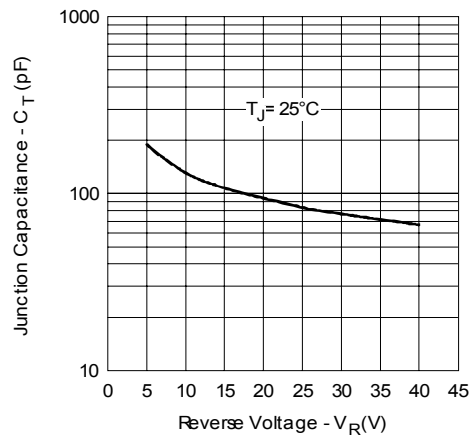

Fig. 3 - Typical Junction Capacitance Vs. Reverse Voltage

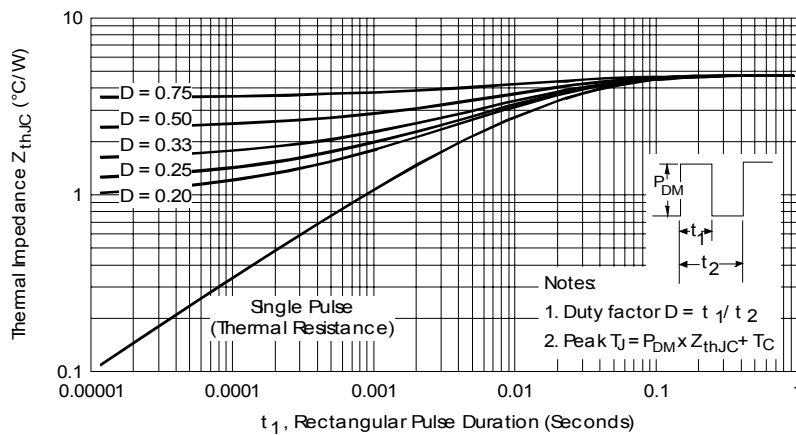

Fig. 4 - Maximum Thermal Impedance Z_{thJC} Characteristics

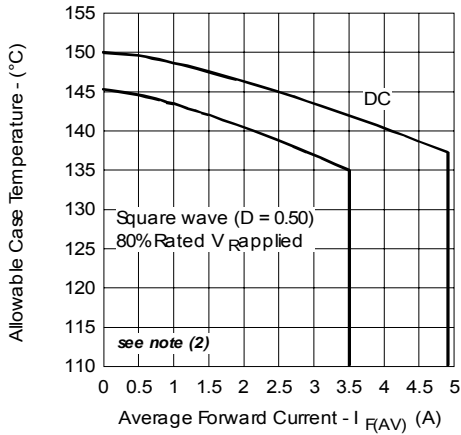

Fig. 5 - Maximum Allowable Case Temperature Vs. Average Forward Current

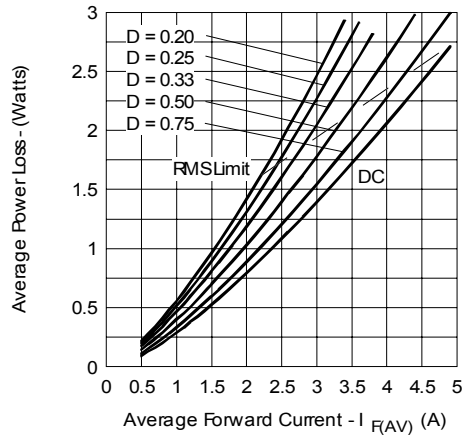

Fig. 6 - Forward Power Loss Characteristics

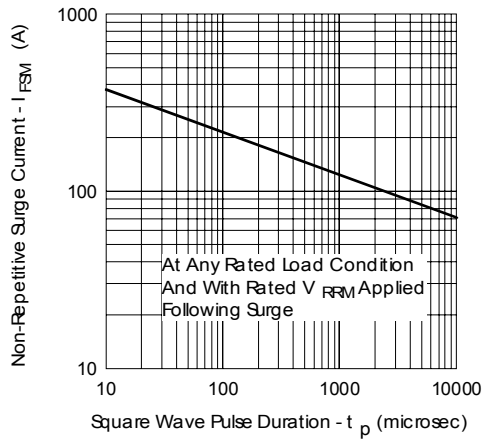

Fig. 7 - Maximum Non-Repetitive Surge Current

(2) Formula used: $T_c = T_j - (Pd + Pd_{REV}) \times R_{thJC}$;

Pd = Forward Power Loss = $I_{F(AV)} \times V_{FM} @ (I_{F(AV)}/D)$ (see Fig. 6);

Pd_{REV} = Inverse Power Loss = $V_{R1} \times I_R (1-D)$; $I_R @ V_{R1} = 80\%$ rated V_R

Outline Table

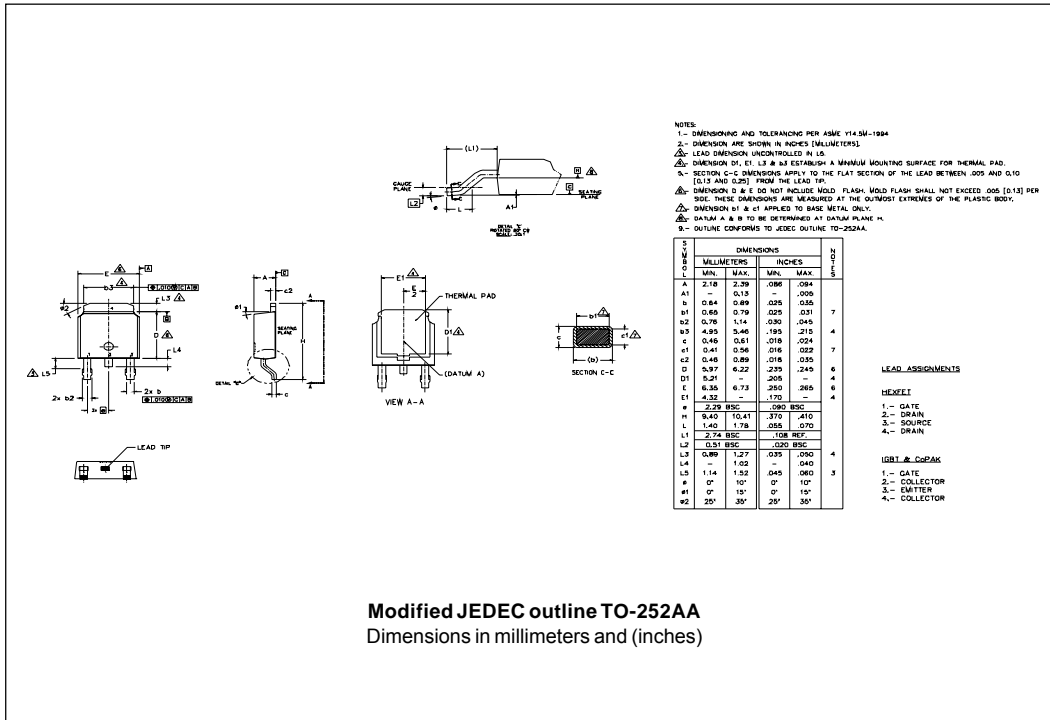

Modified JEDEC outline TO-252AA
 Dimensions in millimeters and (inches)

Part Marking Information

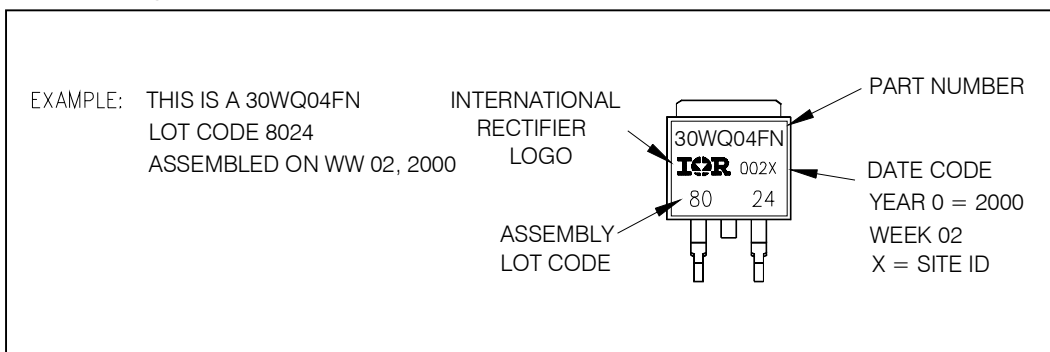

Tape & Reel Information

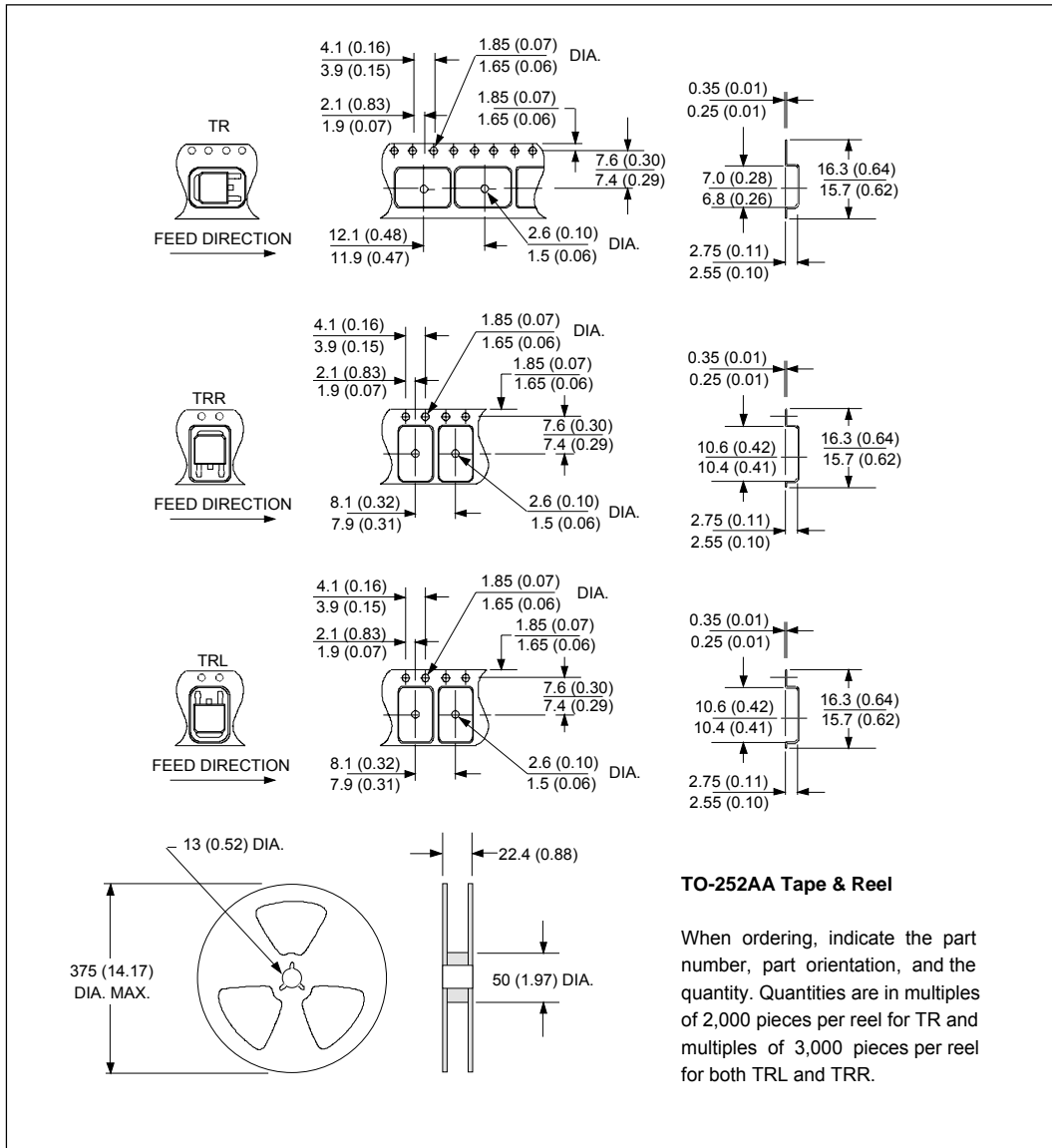

TO-252AA Tape & Reel

When ordering, indicate the part number, part orientation, and the quantity. Quantities are in multiples of 2,000 pieces per reel for TR and multiples of 3,000 pieces per reel for both TRL and TRR.

Ordering Information Table

Device Code															
	<table border="1" style="margin-left: auto; margin-right: auto;"> <tr> <td style="padding: 5px;">30</td> <td style="padding: 5px;">W</td> <td style="padding: 5px;">Q</td> <td style="padding: 5px;">04</td> <td style="padding: 5px;">FN</td> <td style="padding: 5px;">TRL</td> <td style="padding: 5px;">-</td> </tr> <tr> <td style="text-align: center;">①</td> <td style="text-align: center;">②</td> <td style="text-align: center;">③</td> <td style="text-align: center;">④</td> <td style="text-align: center;">⑤</td> <td style="text-align: center;">⑥</td> <td style="text-align: center;">⑦</td> </tr> </table>	30	W	Q	04	FN	TRL	-	①	②	③	④	⑤	⑥	⑦
30	W	Q	04	FN	TRL	-									
①	②	③	④	⑤	⑥	⑦									
1	- Current Rating (3.5A)														
2	- Package Identifier W = D-Pak														
3	- Schottky "Q" Series														
4	- Voltage Rating (04 = 40V)														
5	- FN = TO-252AA														
6	- <ul style="list-style-type: none"> • none = Tube (50 pieces) • TR = Tape & Reel • TRL = Tape & Reel (Left Oriented) • TRR = Tape & Reel (Right Oriented) 														
7	- <ul style="list-style-type: none"> • none = Standard Production • PbF = Lead-Free 														

```

30WQ04FN
*****
* This model has been developed by *
* Wizard SPICE MODEL GENERATOR (1999) *
* (International Rectifier Corporation) *
* contains Proprietary Information *
*****
* SPICE Model Diode is composed by a *
* simple diode plus paralalled VCG2T *
*****
.SUBCKT 30WQ04FN ANO CAT
D1 ANO 1 DMOD (0.01614)
*Define diode model
.MODEL DMOD D(IS=1.1021044955238E-04A,N=1.03763733127871,BV=53V,
+ IBV=0.225832353615935A,RS= 0.000439008,CJO=6.29671162330771E-08,
+ VJ=0.169606385579256,XTI=2, EG=0.72244495735053)
*****
*Implementation of VCG2T
VX 1 2 DC 0V
R1 2 CAT TRES 1E-6
.MODEL TRES RES(R=1,TC1=96.5402599365199)
GP1 ANO CAT VALUE={-ABS(I(VX))*EXP(((((-3.005809E-03/96.54026)*((V(2,CAT)*1E6)/(I(VX)+1E-6)-
1))+1)*6.266778E-02*ABS(V(ANO,CAT)))-1)}
*****
.ENDS 30WQ04FN

Thermal Model Subcircuit
.SUBCKT 30WQ04FN 5 1

CTHERM1 5 4 8.75E-04
CTHERM2 4 3 5.09E+01
CTHERM3 3 2 3.62E+02
CTHERM4 2 1 2.35E+03

R THERM1 5 4 1.00E-07
R THERM2 4 3 2.07E+00
R THERM1 3 2 1.92E+00
R THERM1 2 1 7.07E-01

.ENDS 30WQ04FN

```

Data and specifications subject to change without notice.
This product has been designed and qualified for AEC Q101 Level.
Qualification Standards can be found on IR's Web site.



Notice

The products described herein were acquired by Vishay Intertechnology, Inc., as part of its acquisition of International Rectifier's Power Control Systems (PCS) business, which closed in April 2007. Specifications of the products displayed herein are pending review by Vishay and are subject to the terms and conditions shown below.

Specifications of the products displayed herein are subject to change without notice. Vishay Intertechnology, Inc., or anyone on its behalf, assumes no responsibility or liability for any errors or inaccuracies.

Information contained herein is intended to provide a product description only. No license, express or implied, by estoppel or otherwise, to any intellectual property rights is granted by this document. Except as provided in Vishay's terms and conditions of sale for such products, Vishay assumes no liability whatsoever, and disclaims any express or implied warranty, relating to sale and/or use of Vishay products including liability or warranties relating to fitness for a particular purpose, merchantability, or infringement of any patent, copyright, or other intellectual property right.

The products shown herein are not designed for use in medical, life-saving, or life-sustaining applications. Customers using or selling these products for use in such applications do so at their own risk and agree to fully indemnify Vishay for any damages resulting from such improper use or sale.

International Rectifier®, IR®, the IR logo, HEXFET®, HEXSense®, HEXDIP®, DOL®, INTERO®, and POWIRTRAIN® are registered trademarks of International Rectifier Corporation in the U.S. and other countries. All other product names noted herein may be trademarks of their respective owners.